



The National Archives

www.nationalarchives.gov.uk



The National Archives

Developing interoperable solutions for electronic record management systems

Richard Blake & Ramona Black
National Advisory Services



Supporting interoperability

- Migrating records to support machinery of government changes
- Facilitating public sector re-use of information
- Potential to enable shared infrastructures in the future
- Support digital preservation solutions

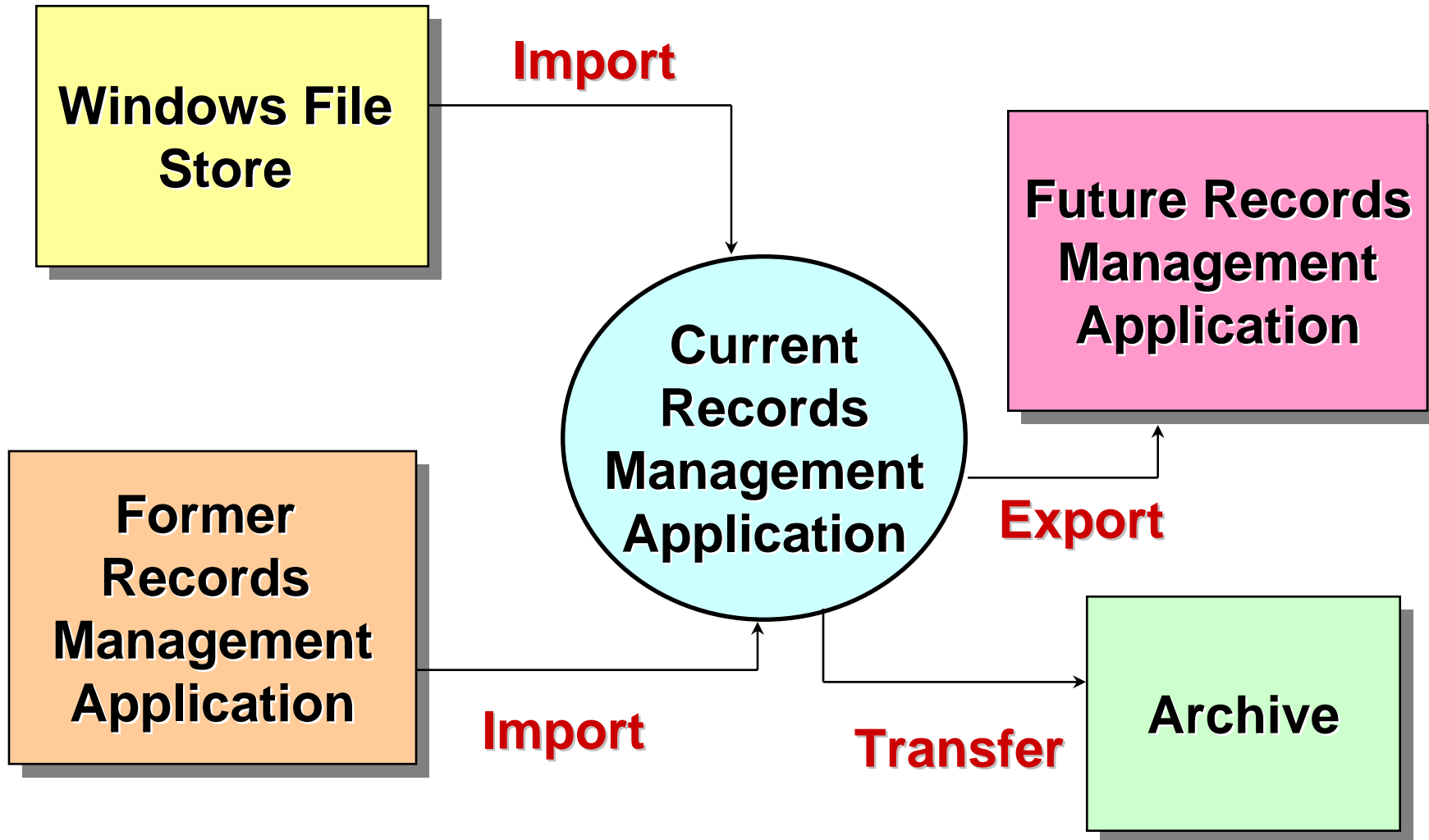



Export and Import Reality

Multiple Data Conversion and Processing

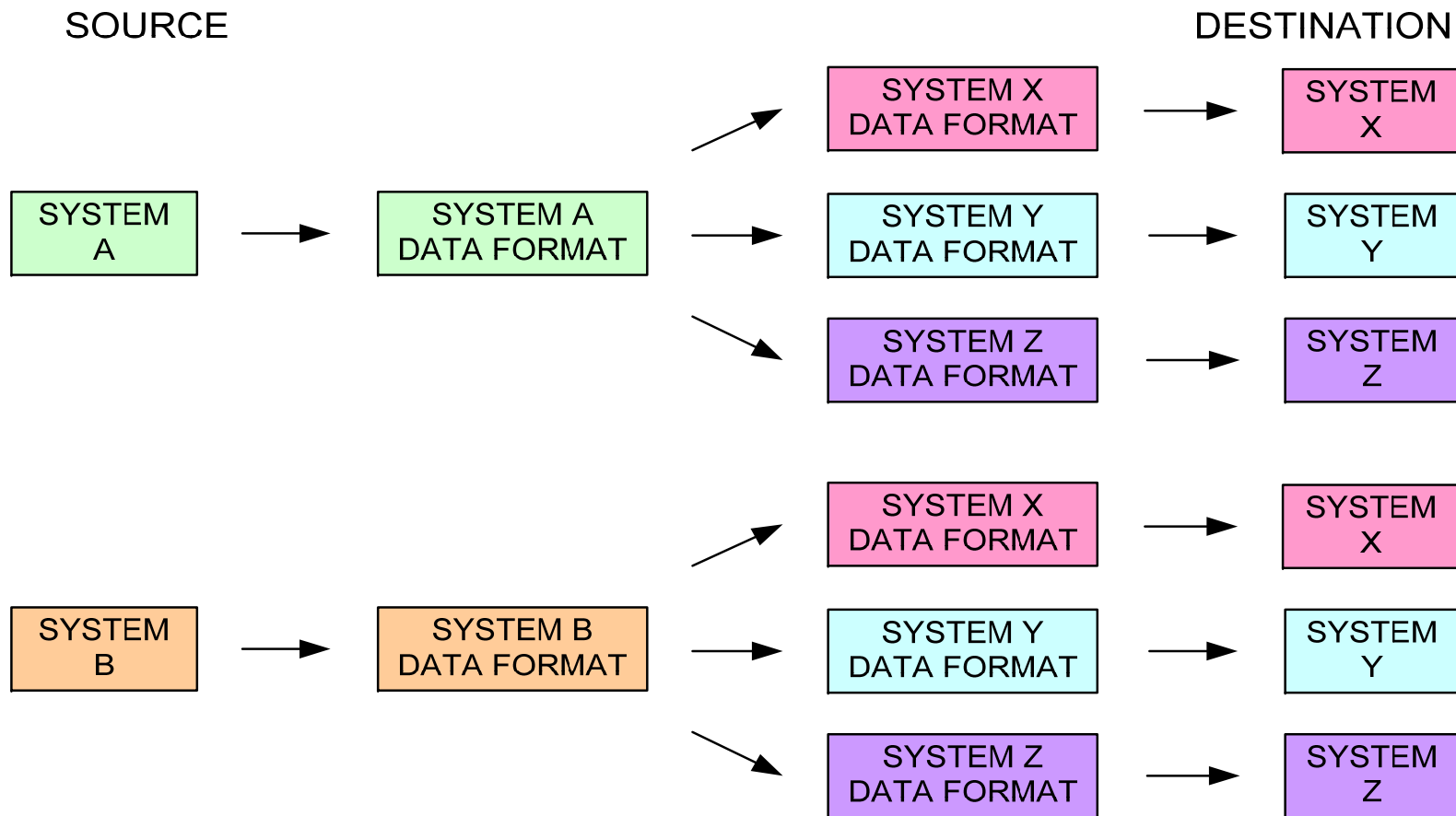



Minimal Data Conversion and Processing

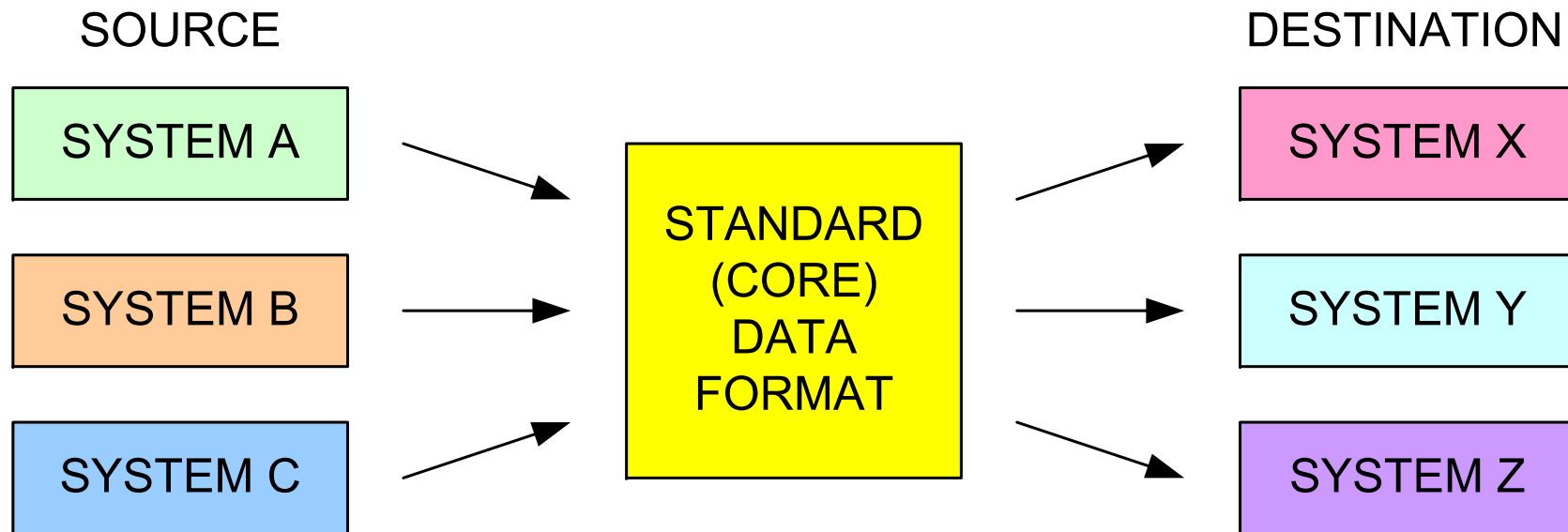



The National Archives

www.nationalarchives.gov.uk



Systems

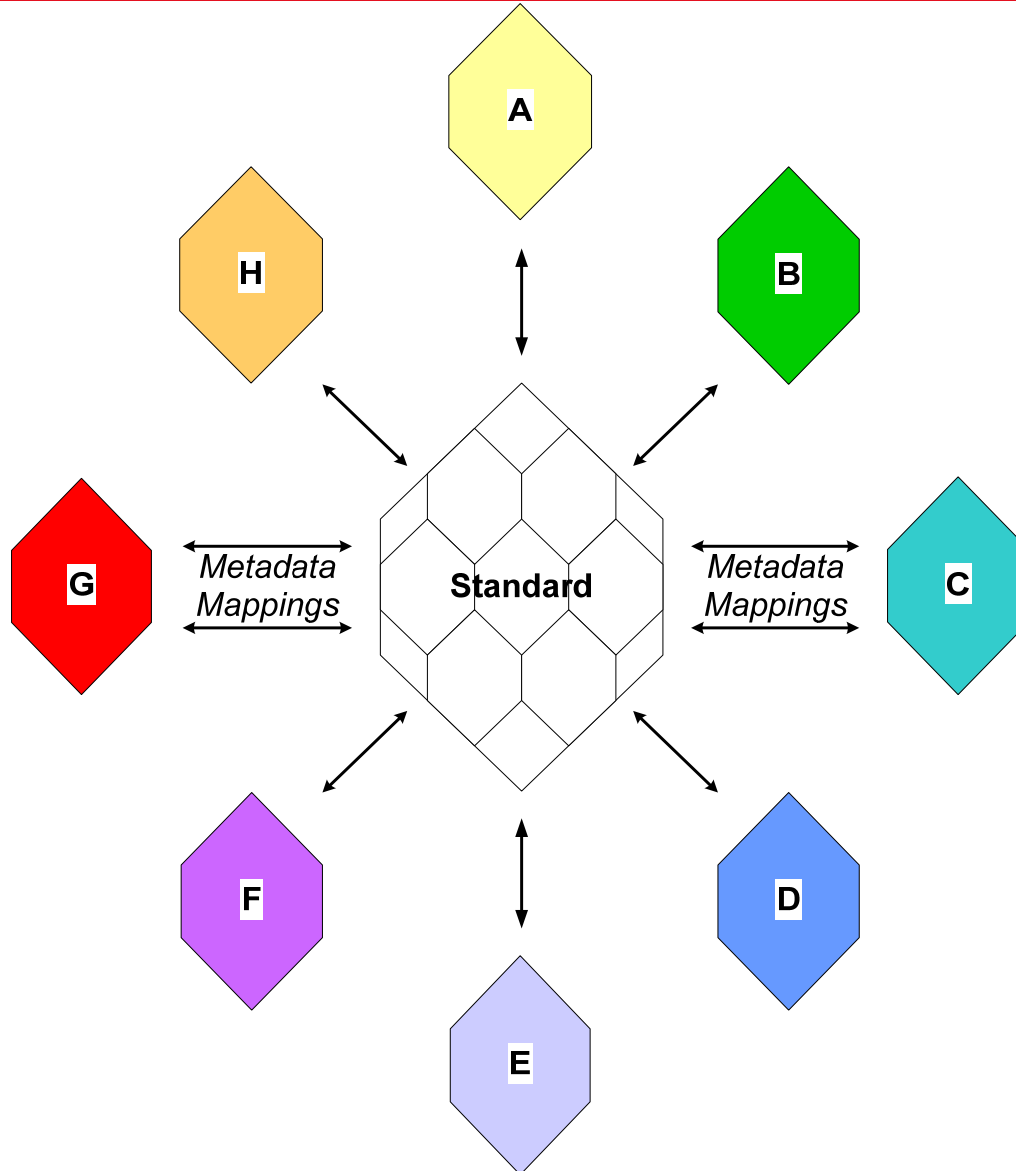
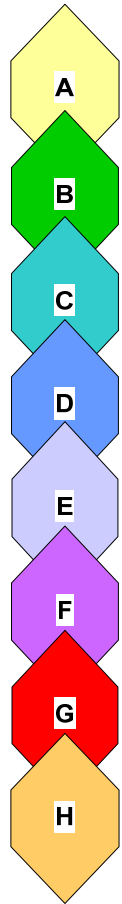



XML Schema Project

Progress

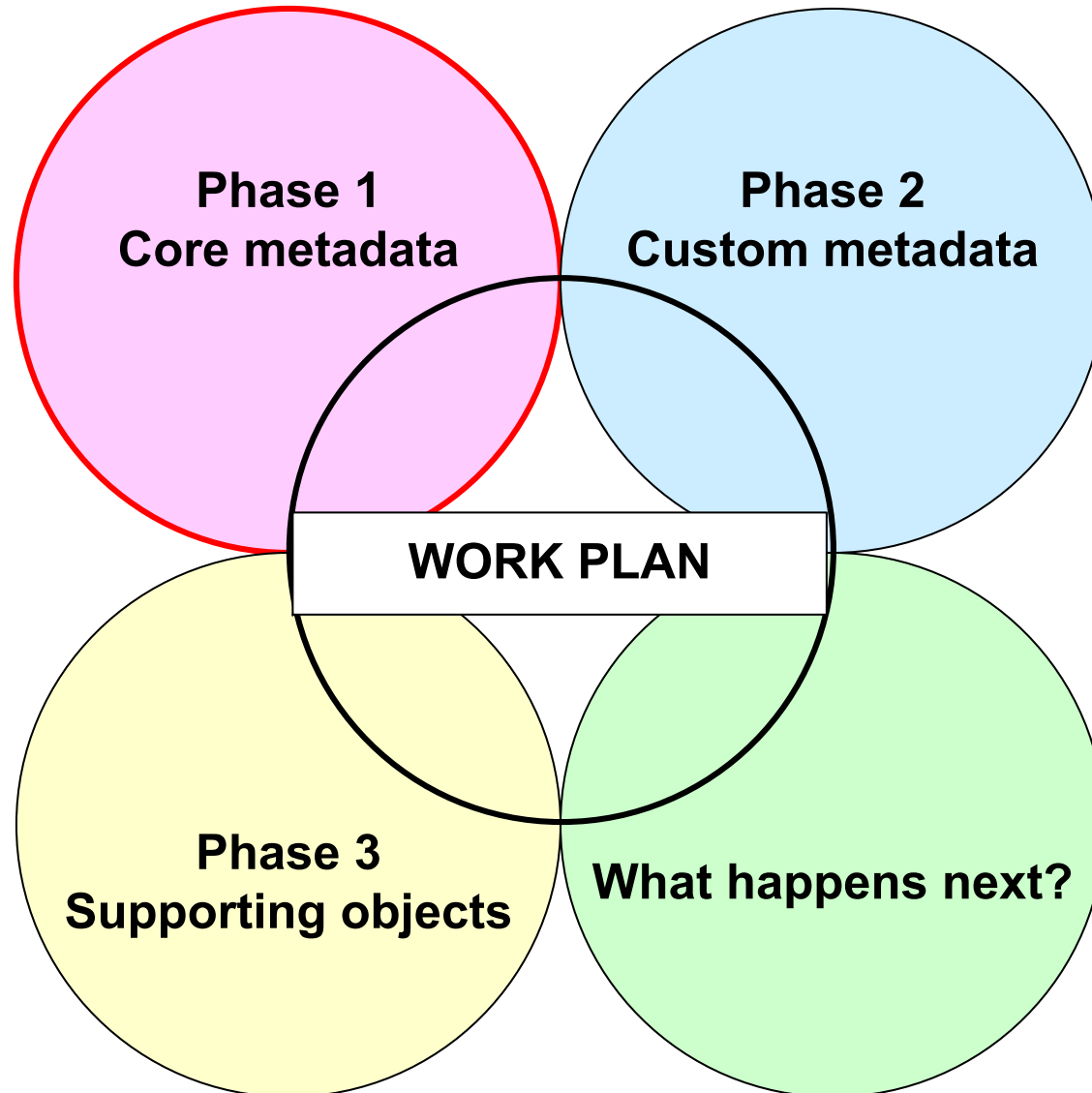



Core Metadata

Phase 1

Metadata Details

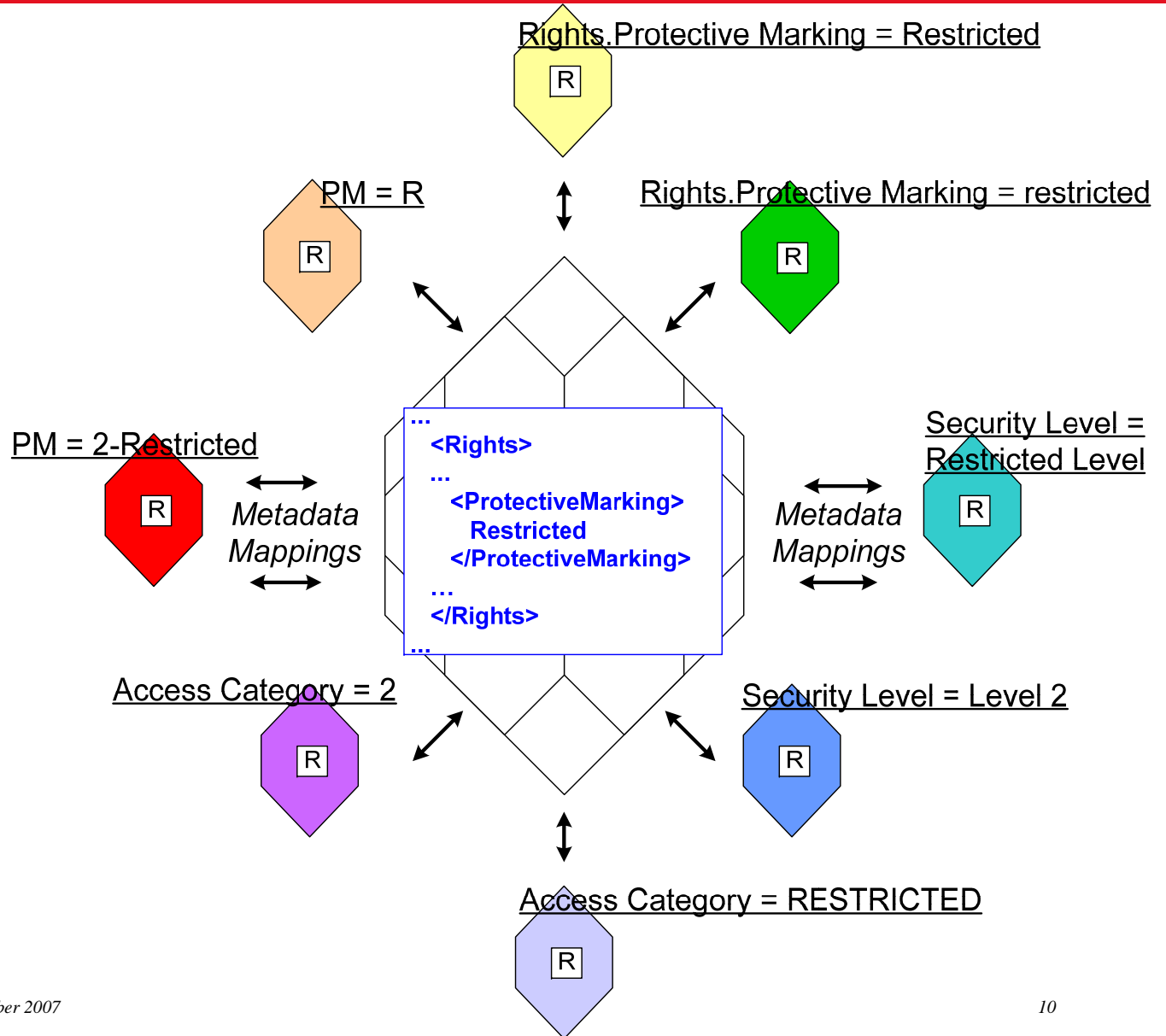
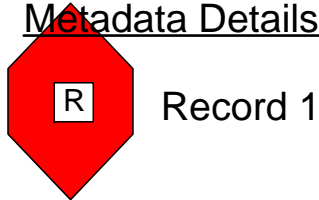



The National Archives

Supporting Object Metadata

Phase 3

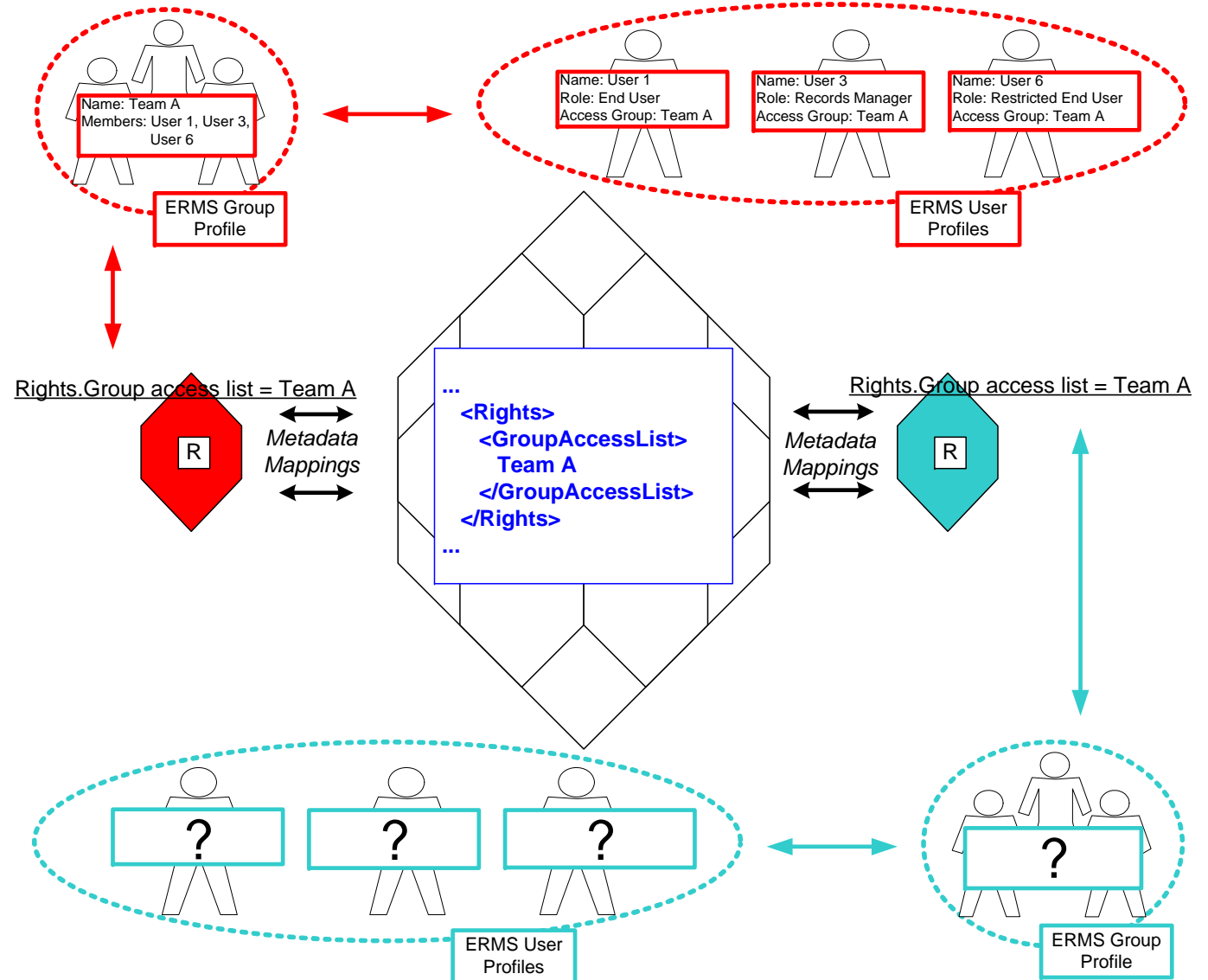



Issues

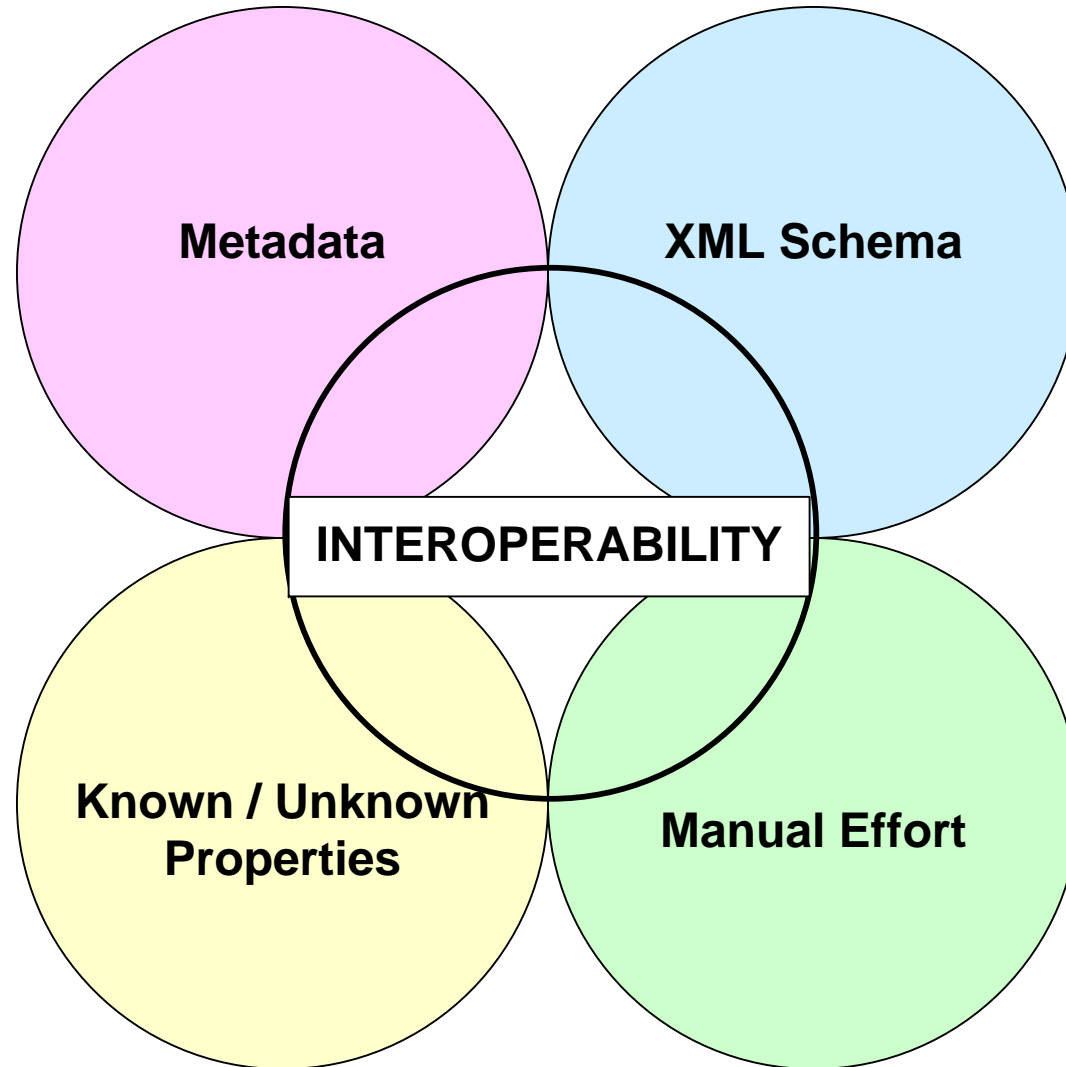



Use

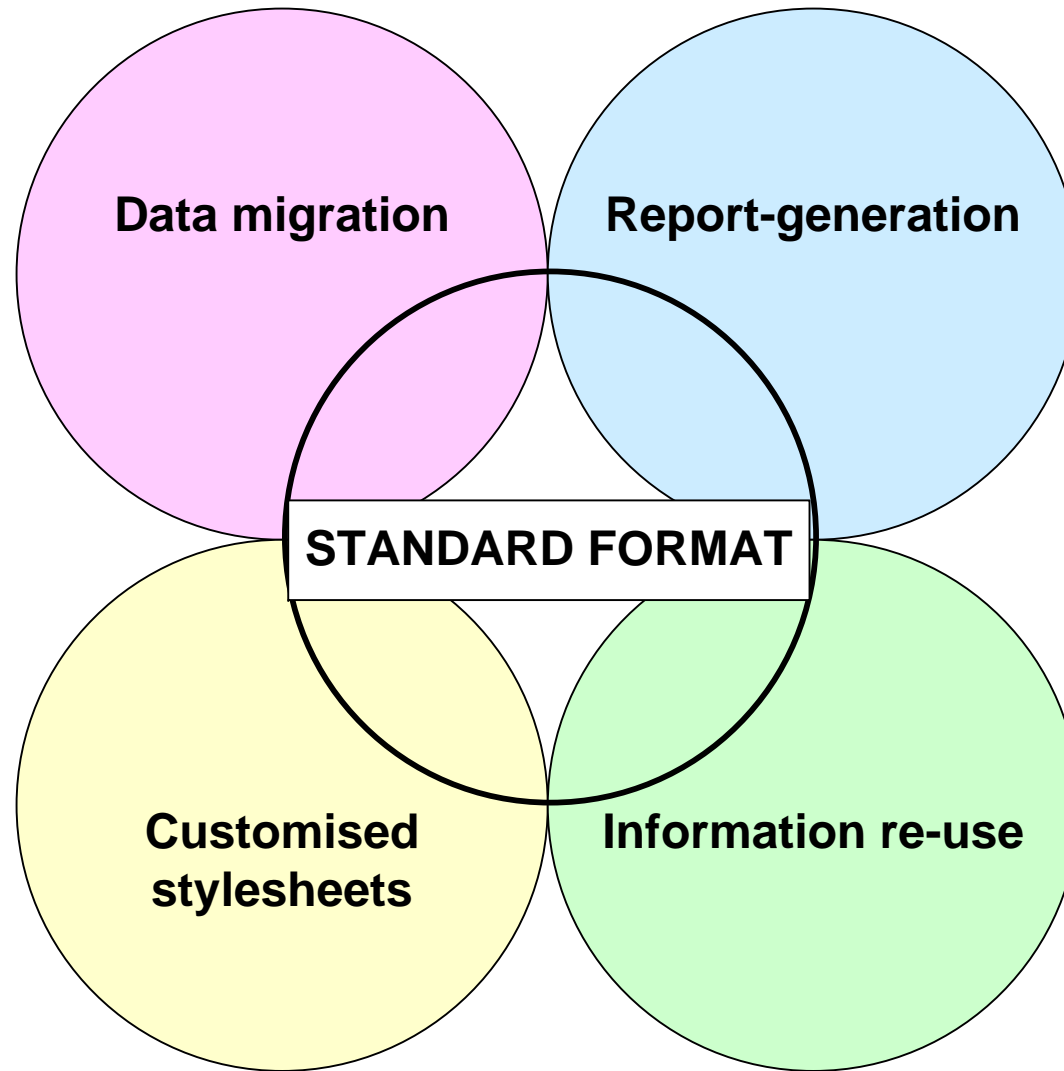



XML Schema Hierarchy

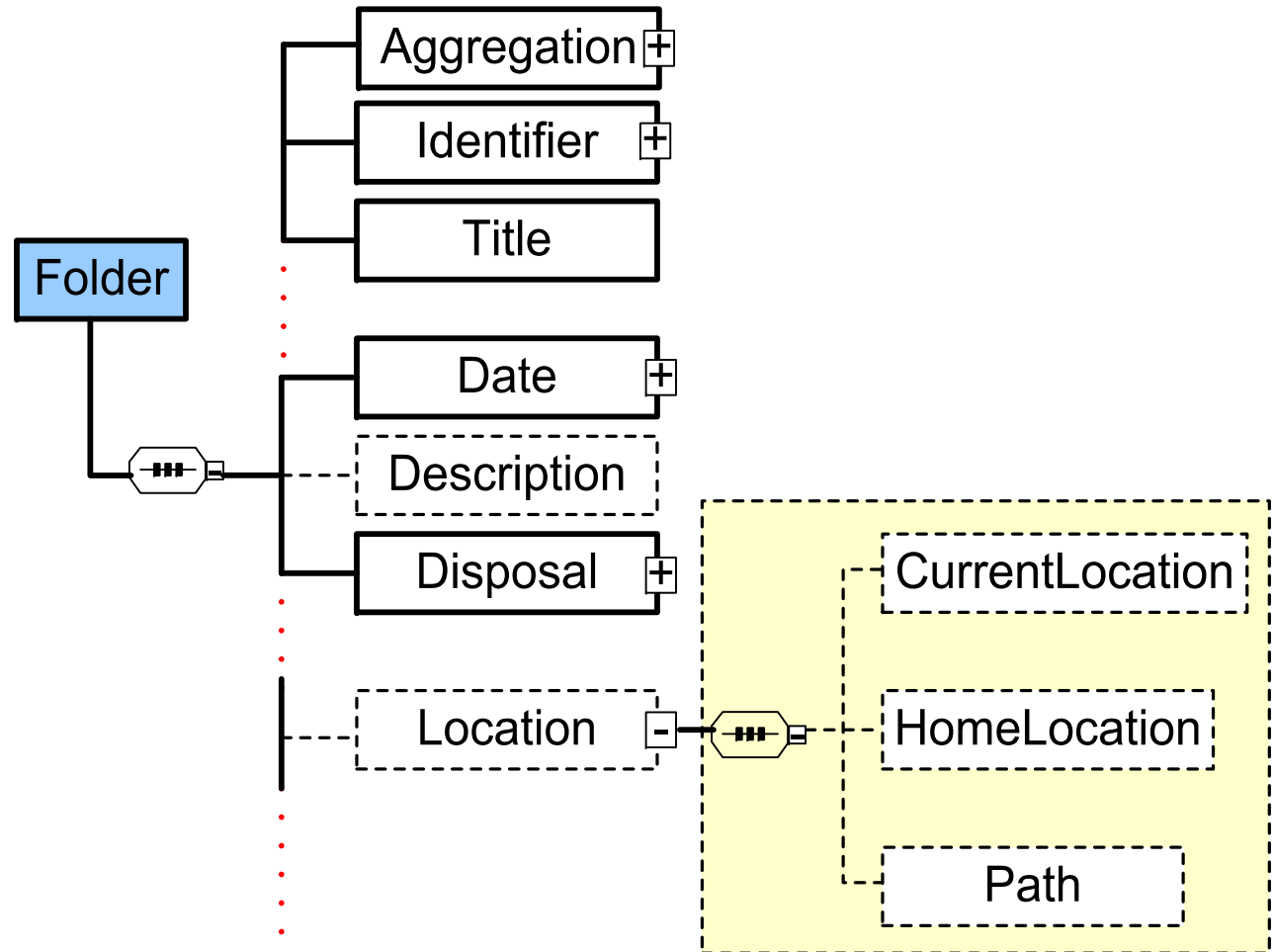
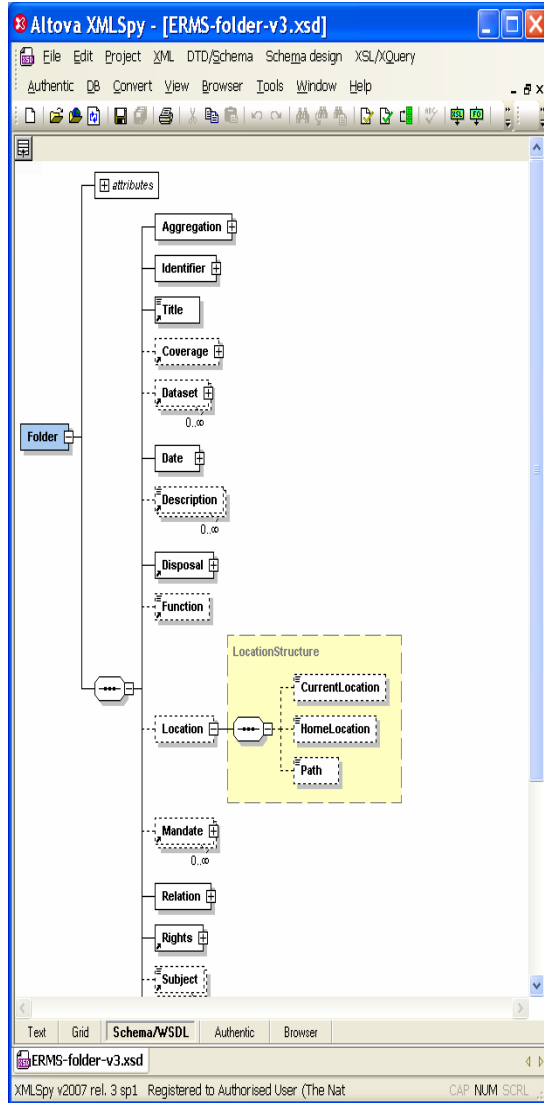



The National Archives

Supporting Documentation



Contents

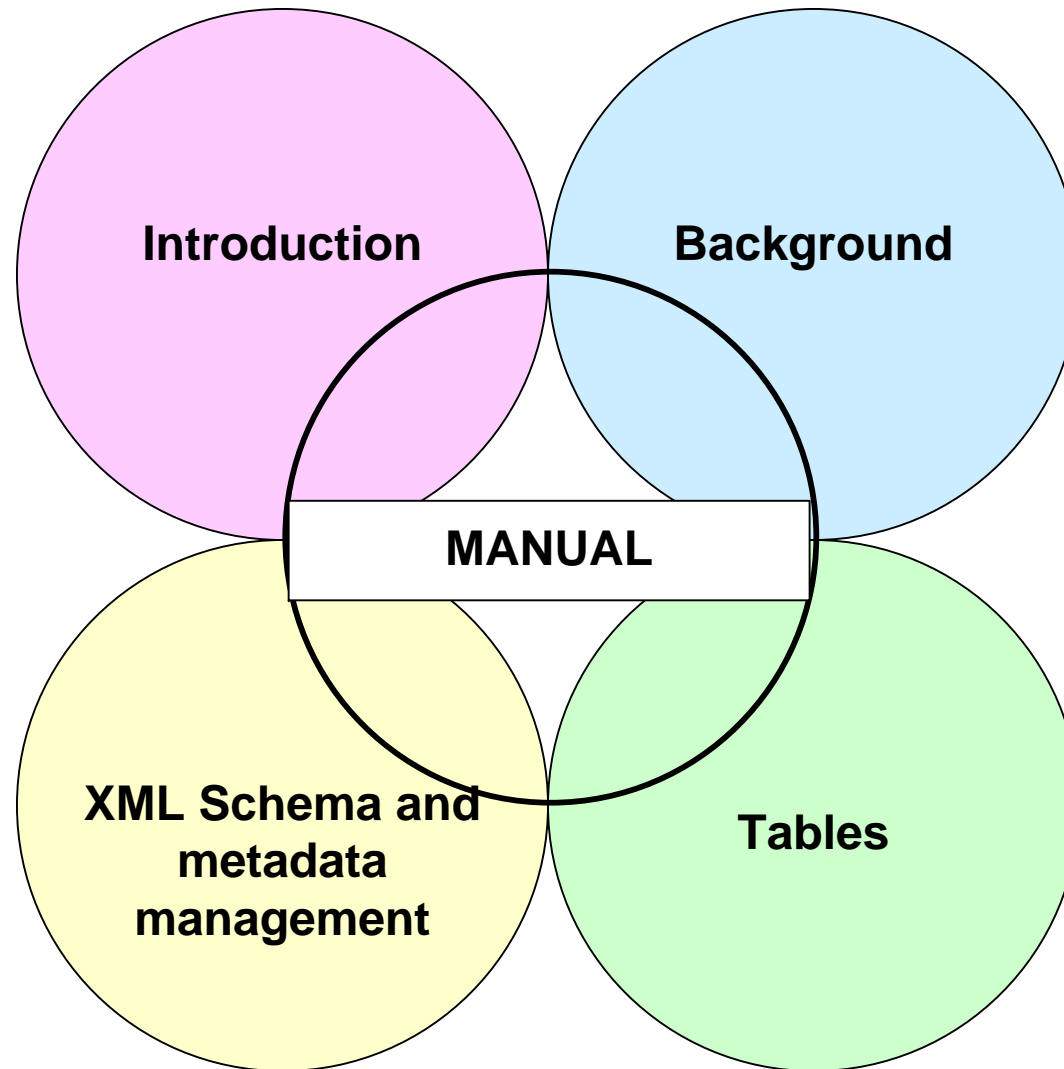



Tables

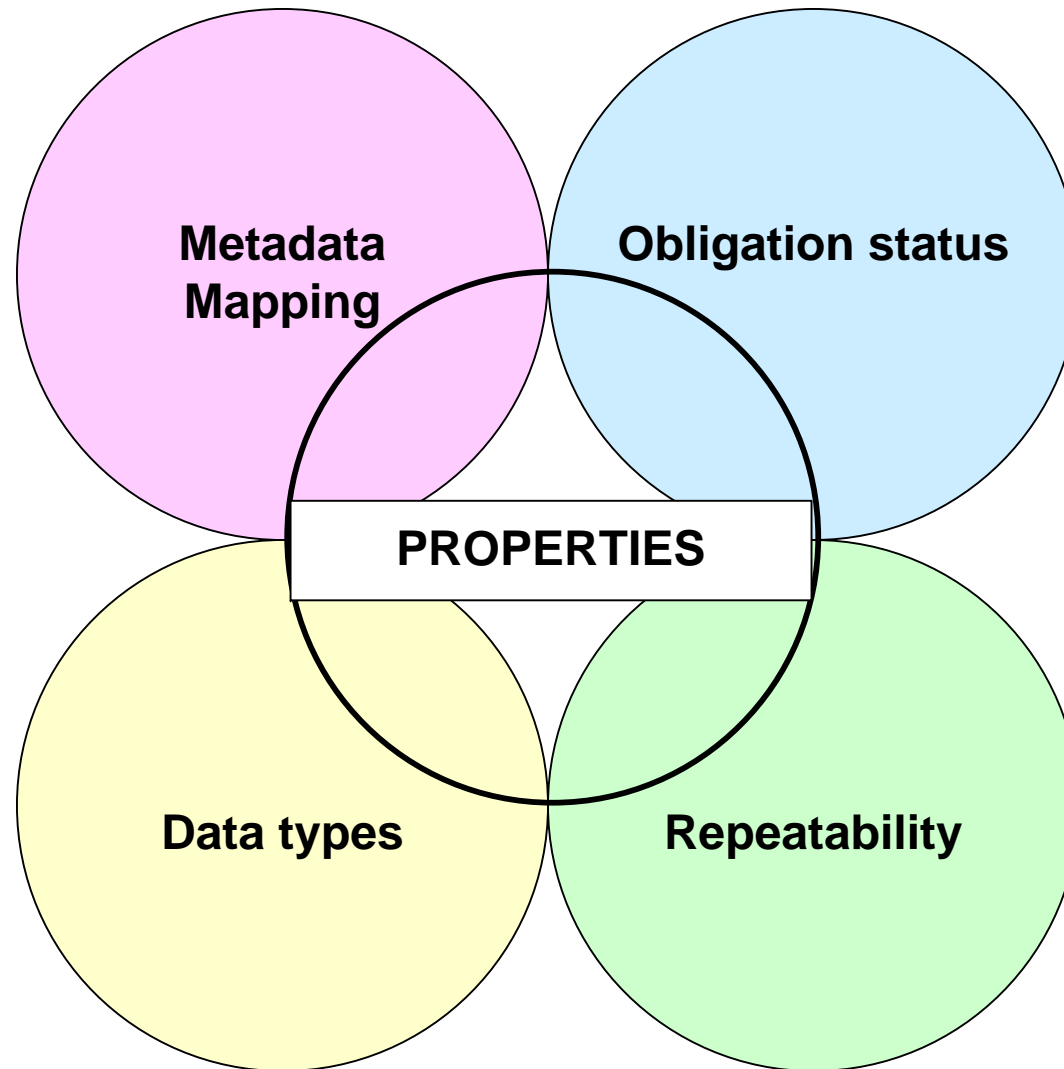



The National Archives

Testing



Steps

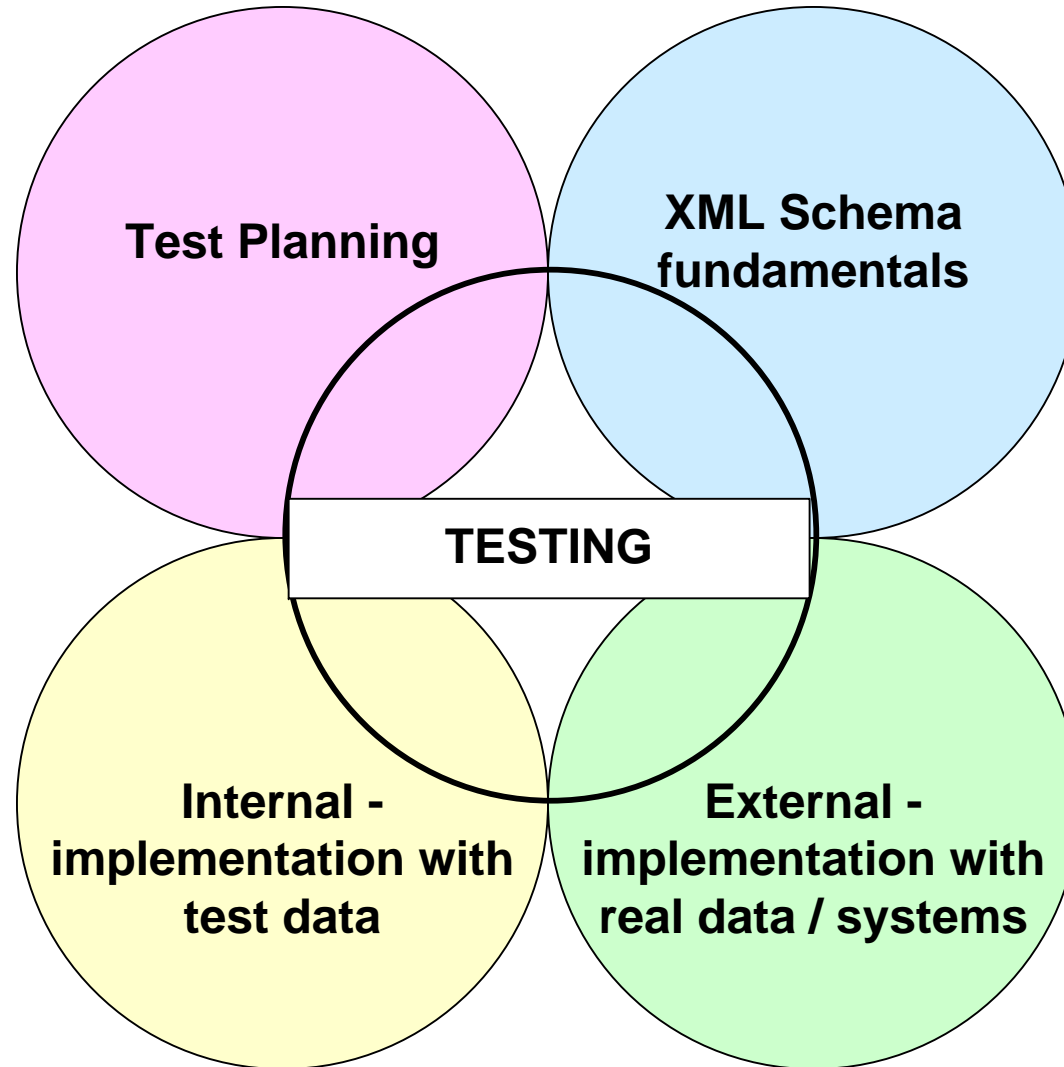



Test Case Fileplan A

Branch 1

Test Case Fileplan A

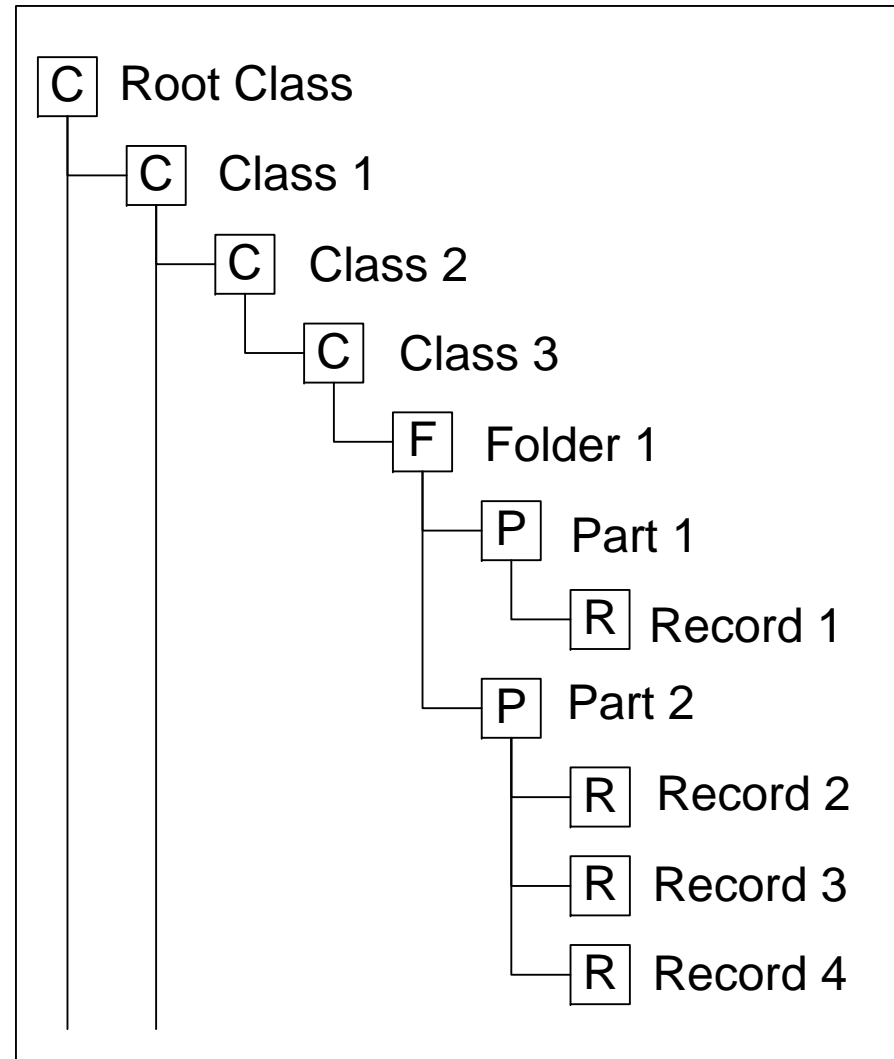
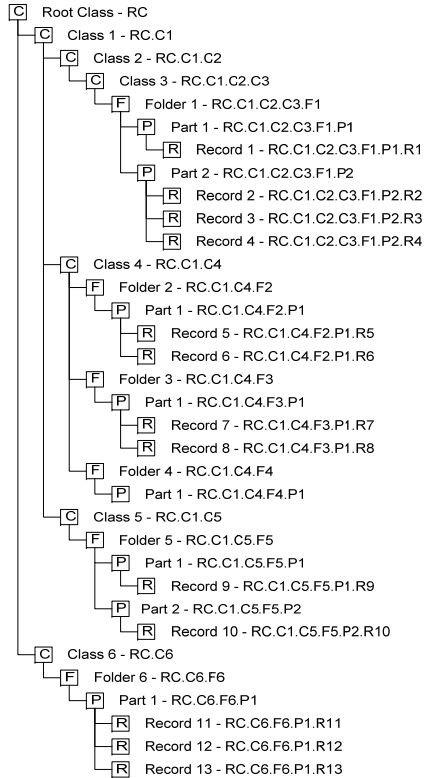



The National Archives

Questions?

<http://www.nationalarchives/electronicrecords>

rmadvisory@nationalarchives.gov.uk



The National Archives

www.nationalarchives.gov.uk